



0-441-61 - LED Amber Corner Warning Lamp

Durite LED Amber Corner Warning Lamp.

Voltage: 12-24V

44pcs Amber high intensity LEDs

36 Flash Patterns

Material: Polycarbonate Lens / Aluminium Housing

IP67

Fly lead 40cm

E Marked R65 & R10 EMC



THE TRUSTED QUALITY BRAND FOR PROFESSIONALS

WARNINGS

Before using this unit please read these instructions carefully. Take special care to follow the warnings and safety suggestions listed below. Keep these instructions for future reference.

SAFETY WARNING

1. Proper installation of this product requires the installer to have a good understanding of automotive electronics, systems and procedures.
2. If mounting this product requires drilling holes, the installer **MUST** be sure that no vehicle components or other vital parts could be damaged by the drilling process. Check both sides of the mounting surface before drilling begins. Also de-burr the holes and remove any metal shards or remnants.
3. Do not install this product or route any wires in the deployment area of your air bag. Equipment mounted or located in the air bag deployment area will damage or reduce the effectiveness of the air bag, or become a projectile that could cause serious personal injury or death. Refer to your vehicle owner's manual for the air bag deployment area. The User/Installer assumes full responsibility to determine proper mounting location, based on providing ultimate safety to all passengers inside the vehicle.
4. Do not attempt to activate or control this device in a hazardous driving situation.
5. This product contains either strobe light(s), halogen light(s), high-intensity LEDs or a combination of these lights. Do not stare directly into these lights. Momentary blindness and/or eye damage could result.
6. All connections must use waterproof connectors and any unconnected wires must be sealed to prevent water ingress via the wire core, failure to do this may result in premature failure and invalidate the warranty.
7. Use only soap and water to clean the outer lens. Use of other chemicals could result in premature lens cracking (crazing) and discoloration. Lenses in this condition have significantly reduced effectiveness. Inspect and operate this product regularly to confirm its proper operation and mounting condition.
8. It is recommended that these instructions be stored in a safe place and referred to when performing maintenance and/or reinstallation of this product.
9. For this product to operate at optimum efficiency, a good electrical connection to chassis ground must be made. The recommended procedure requires the product ground wire to be connected directly to the **NEGATIVE (-)** battery post.

ACCESSORIES

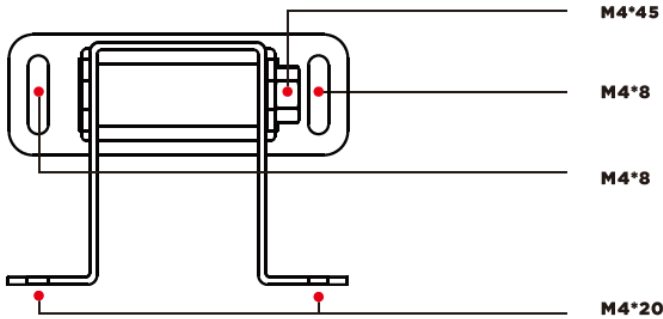
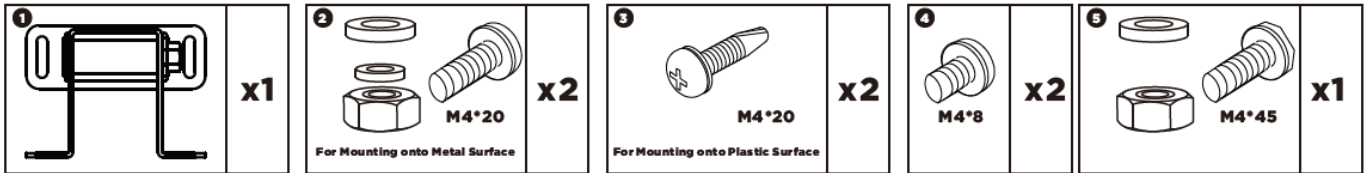

WIRING

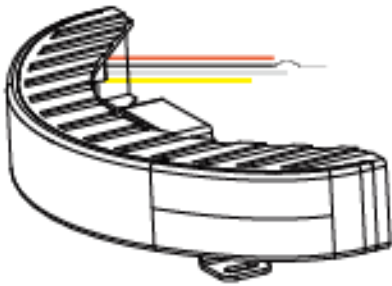

- Red** ————— **+V DC**
- Black** ————— **-V DC**
- White** ————— **Synchronization**
- Yellow** ————— **Pattern switch**

SINGLE GROUP WIRING & OPERATION

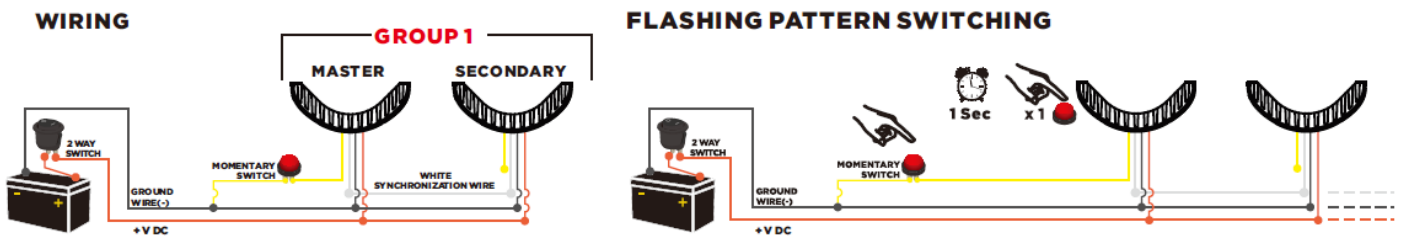

SINGLE GROUP MODE (SYNCHRONIZING MODE ONLY):
 All lights will be connected as 1 Group.
 All the patterns will be in Synchronization Mode.

TWO GROUP WIRING & OPERATION

WIRING

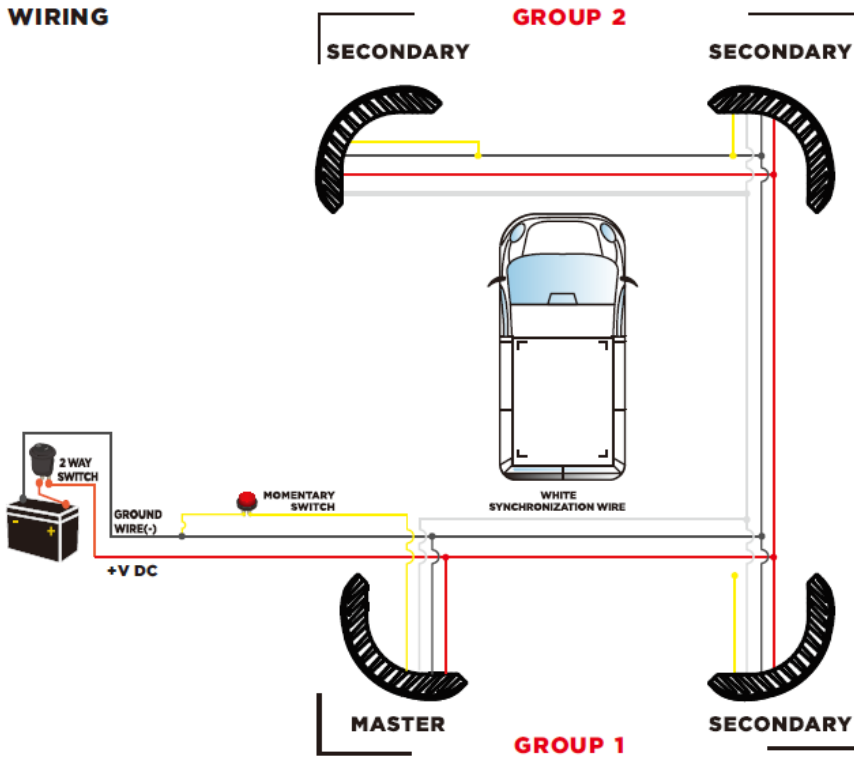

FLASHING PATTERN SWITCHING

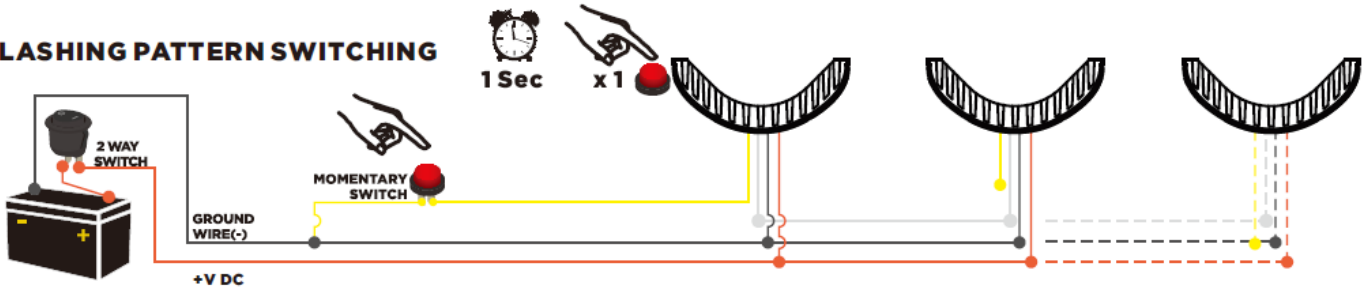

DUAL GROUP MODE (ALTERNATING & SYNCHRONIZING MODES):

All lights will be divided in 2 Groups. Depending on the flash pattern selected, Group 1 lights can alternate or synchronize with Group 2 lights.

Master Setting

- 1) TO SET THE MASTER: Before attaching the momentary switch, turn power ON and the lights will begin to flash. Touch the **YELLOW WIRE** of your Master Light choice to the **BLACK WIRE (-)** for 5 seconds to designate this light as the Master. Once you see a change (Flash or Steady Light), this Master light will be confirmed and will automatically set all the secondary lights to the same flash pattern as the Master. If unsuccessful, turn power OFF and ON again and repeat this step. (It is recommended that the Master Light be the first point of contact to the battery.)
- 2) Once the Master is set, permanently connect its **YELLOW WIRE** to the MOMENTARY SWITCH (not included). Then connect an extra wire from the MOMENTARY SWITCH to the **BLACK WIRE (-)** that is connected to the ground of the power supply or the chassis.
- 3) Once wiring is complete, all the secondary lights will automatically change to any pattern that the Master light is set to.

Favorite Pattern Designating & Calling

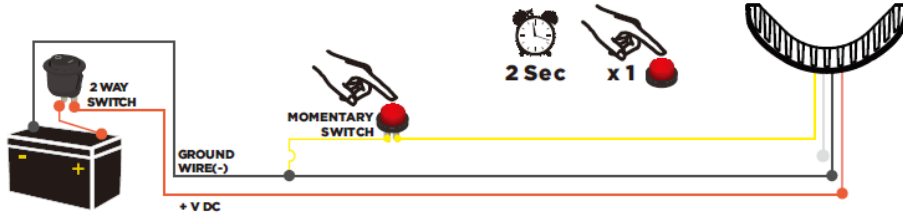

Favorite Pattern Designating

When your favorite flashing pattern is running, keep pressing the "Momentary switch" for 2sec, then all the lights will fixed illuminating for 1.5sec, then extinguish. your favorite flashing pattern has been stored successfully

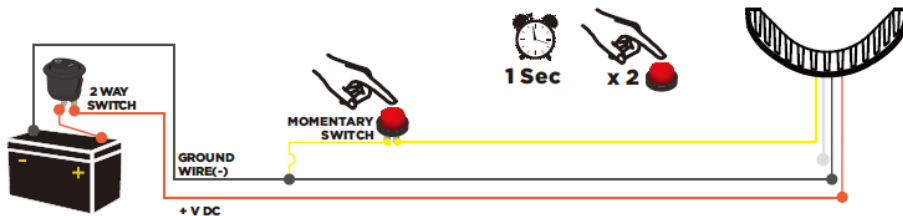

Favorite Pattern Calling

When you want the lights execute your favorite flashing pattern, press the "Momentary switch" twice in 0.5sec, the lights will execute your favorite flashing pattern. There are 3 favorite flashing patterns maximum can be designated for one light system, when you call the 3 favorite flashing patterns, press the "Momentary switch" twice in 0.5sec, the flashing patterns will shifted circularly in the sequence of the favorite patterns designating

FLASH PATTERNS

FLASH #	FLASH PATTERN	FPM
1	Single Flash (Slow)	75
2	Single Flash (Slow) - Low Power	75
3	Single Flash (Slow) - Alternating Individually	75
4	Single Flash (Slow) - Alternating Group	75
5	Single Flash - ECE R65	125
6	Single Flash - Low Power	125
7	Single Flash - Alternating Individually	125
8	Single Flash - Alternating Group	167
9	Double Flash (Slow)	75
10	Double Flash (Slow) - Alternating Individually	75
11	Double Flash (Slow) - Alternating Group	68
12	Double Flash (Fast) - ECE R65	125
13	Double Flash (Fast) - Low Power	125
14	Double Flash (Fast) - Alternating Individually	125
15	Double Flash (Fast) - Alternating Group	150
16	Triple Flash	75
17	Triple Flash - Alternating Individually	75
18	Triple Flash - Alternating Group	88

FLASH #	FLASH PATTERN	FPM
19	Quad Flash (Slow)	79
20	Quad Flash (Slow) - Alternating Individually	79
21	Quad Flash (Slow) - Alternating Group	63
22	Quad Flash (Fast) - ECE R65	125
23	Quad Flash (Fast) - Alternating Individually	117
24	Quad Flash (Fast) - Alternating Group - ECE R65	125
25	Octa (8) Flash	79
26	Octa (8) Flash - Alternating Individually	79
27	Octa (8) Flash - Alternating Group	63
28	Continuously Flash (Fast)	750
29	Automatically Flash 5/28	-
30	Automatically Flash 12/16	-
31	Single Flash (Split Accelerate)	-
32	Double Flash (Split Accelerate)	-
33	SOS Flash	-
34	Random	-
35	Steady On	-
36	Standby (Inactive)	-

TECHNICAL SPECIFICATIONS

Type	Warning Lamp - Amber.
Voltage	10-30VDC
LED's	Warning 0.5W x 44 Amber LED's.
Power	15W Max (22W Theoretical Power)
Current Draw	1A at 12VDC, 0.5A at 24VDC
Flash Patterns	36
IP Rating	IP67
Material Construction	PC Lens, Aluminium Housing
Weight	0.350Kg
Dimensions	Please see below
Operating Temperature	-30°C to +60°C
Storage Temperature	-30°C to +60°C
Certificate	CE, E Mark R10 EMC, R65

TECHNICAL DRAWING

